



9505

Multiplicador de par manual con placa de reacción



DETALLES DEL PRODUCTO

- La placa de reacción con punto deslizante permite elegir el mejor punto de reacción para el trabajo a realizar.
- Utilizar siempre con llave dinamométrica (CW y CCW) para evitar sobrepasar el par máximo del multiplicador
- Precisión ± 4
- Se suministra en bolsa de tela
- Fabricado en el Reino Unido

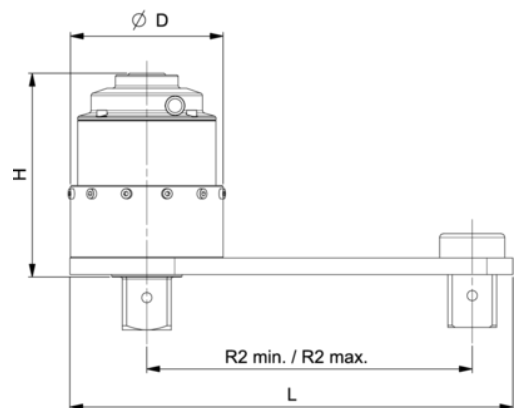











Follow the Fish!



ATRIBUTOS DE PRODUCTO

Producto: 9505-3400

| | | | | | |
|---|----------|---|----------|---|--------|
|  | 3400 N·m |  | 3/4 in |  | 5.2:1 |
|  | 653 N·m |  | 1 in |  | 119 mm |
|  | 106 mm |  | 355 mm |  | 86 mm |
|  | 263 mm |  | 7.200 kg | | |

Follow the Fish!

